

|           |       |
|-----------|-------|
| PROJECT   | _____ |
| TYPE      | _____ |
| SPECIFIER | _____ |
| QUANTITY  | _____ |
| DATE      | _____ |

## OIKO PRO WALLWASH RECESSED

### A35865-

base number    Finishes (Diamond)    Lens Options

- To build a product code in our configurator select the specify button on the base model # product page
- To build a manual product code on this datasheet choose from the options listed below in blue font and add the suffix to the base model #

#### GENERAL

Series: Oiko Pro  
 Subseries: Oiko Pro Wallwash  
 Brand: Prolicht  
 Division: Architectural  
 Mounting Type: Recessed  
 Mounting Location: Ceiling  
 Subcategory: Downlight

#### PHYSICAL

Shape: Round  
 Diameter (mm): 75  
 Diameter (in): 2 15/16  
 Height (mm): 51  
 Height (in): 2  
 Ceiling Thickness (mm): 1 - 25  
 Ceiling Thickness (in): 1/16 - 1 3/16  
 Min. Recessing Depth (mm): 55  
 Min. Recessing Depth (in): 2 3/16  
 Light Distribution: Downlight  
 Diffuser: Lens Pack - Spread Lens / Linear Spread Lens / Honeycomb Louver  
 Fixture Finish: SSR / BKV / CWI / CRY / HAB / LAG / UFT / ITA / RUA / RUR / MIC / FTG / MYG / TWT / LOD / PUS / FRO / FUP / KIA / POP / BLS / SPG / MEY / GOH / GUM / CHC / COM / ABZ / JAG / OBR / MOS / ROR  
 Fixture Material: Aluminum Die Cast  
 Cut-out Measurements: 68mm / 2 11/16" Diameter

#### ELECTRICAL

Lamp Type: LED (Zhaga Standard)  
 Input Wattage (W): 14  
 Total Output Wattage (W): 12.7  
 Dimming: Dali Dimming  
 Driver Included: No  
 Driver Location: Recessed Housing  
 Driver Type: Constant Current - Universal (120Vac only for DALI driver)  
 Driver Class: Class 2  
 Input Voltage (V): 120 - 277  
 Constant Current (MA): 700

#### LED

Color Temperature (°K): 2700-6500 Tunable White  
 Max. Delivered Lumen (lm): 1216  
 Nominal Lumen (lm): 1460  
 CRI: >90 CRI  
 Lamp Life (hrs): 50000  
 Special LEDs offerings: Tunable White

#### OPTICAL

Adjustability: Fixed

#### RATINGS AND CERTIFICATIONS

Certified By: Certified for North American Standards  
 IP rating: IP20

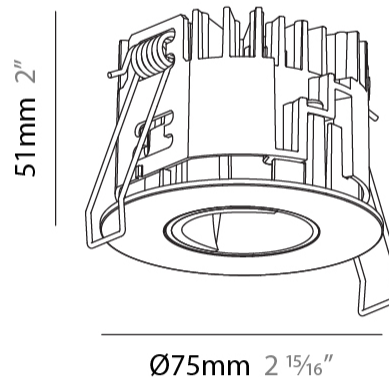
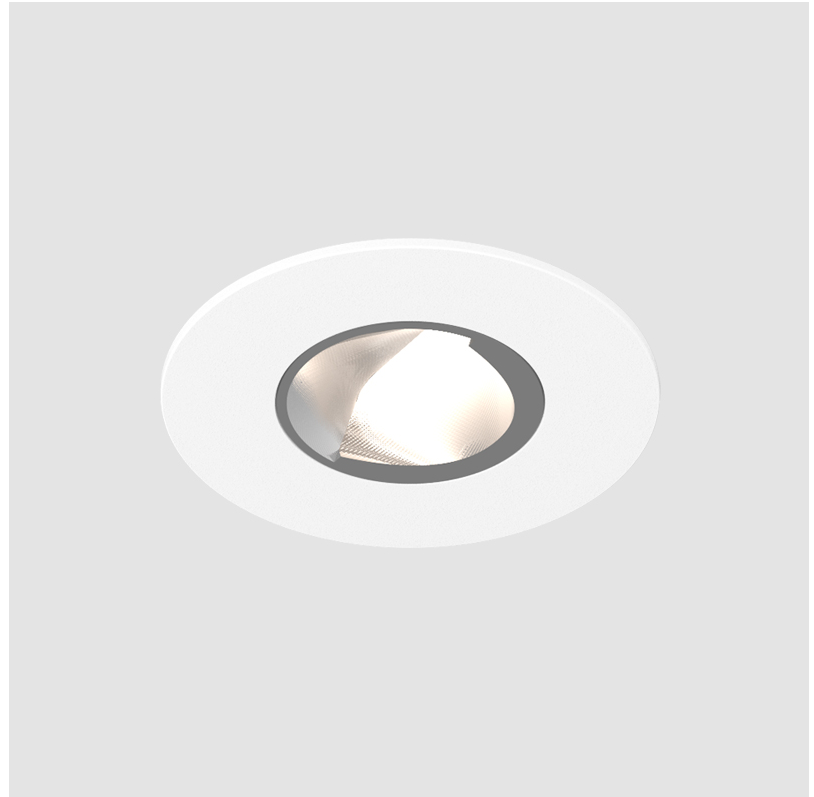

## OIKO PRO WALLWASH RECESSED

A35865-

PROJECT

TYPE

SPECIFIER

QUANTITY

DATE



A

|           |       |
|-----------|-------|
| PROJECT   | _____ |
| TYPE      | _____ |
| SPECIFIER | _____ |
| QUANTITY  | _____ |
| DATE      | _____ |

## OIKO PRO ROUND RECESSED

**A35872-** \_\_\_\_\_ - \_\_\_\_\_

base number    Finishes (Diamond)    Lens Options

- To build a product code in our configurator select the specify button on the base model # product page
- To build a manual product code on this datasheet choose from the options listed below in blue font and add the suffix to the base model #

### GENERAL

Series: Oiko Pro  
 Subseries: Oiko Pro Round  
 Brand: Prolicht  
 Division: Architectural  
 Mounting Type: Recessed  
 Mounting Location: Ceiling  
 Subcategory: Downlight

### PHYSICAL

Shape: Round  
 Diameter (mm): 75  
 Diameter (in): 2 15/16  
 Height (mm): 51  
 Height (in): 2  
 Ceiling Thickness (mm): 1 - 25  
 Ceiling Thickness (in): 1/16 - 1 3/16  
 Min. Recessing Depth (mm): 55  
 Min. Recessing Depth (in): 2 3/16  
 Light Distribution: Direct  
 Diffuser: Lens Pack - Spread Lens / Linear Spread Lens / Honeycomb Louver  
 Fixture Finish: SSR / BKV / CWI / CRY / HAB / LAG / UFT / ITA / RUA / RUR / MIC / FTG / MYG / TWT / LOD / PUS / FRO / FUP / KIA / POP / BLS / SPG / MEY / GOH / GUM / CHC / COM / ABZ / JAG / OBR / MOS / ROR  
 Fixture Material: Aluminum Die Cast  
 Cut-out Measurements: 68mm / 2 11/16" Diameter

### ELECTRICAL

Lamp Type: LED (Zhaga Standard)  
 Input Wattage (W): 14  
 Total Output Wattage (W): 12.7  
 Dimming: Dali Dimming  
 Driver Included: No  
 Driver Location: Recessed Housing  
 Driver Type: Constant Current - Universal (120Vac only for DALI driver)  
 Driver Class: Class 2  
 Input Voltage (V): 120 - 277  
 Constant Current (MA): 700

### LED

Color Temperature (°K): 2700-6500 Tunable White  
 Max. Delivered Lumen (lm): 1240  
 Nominal Lumen (lm): 1460  
 CRI: >93 CRI  
 Lamp Life (hrs): 50000  
 Special LEDs offerings: Tunable White

### OPTICAL

Reflector°: 52  
 Adjustability: Fixed

### RATINGS AND CERTIFICATIONS

Certified By: Certified for North American Standards  
 IP rating: IP20

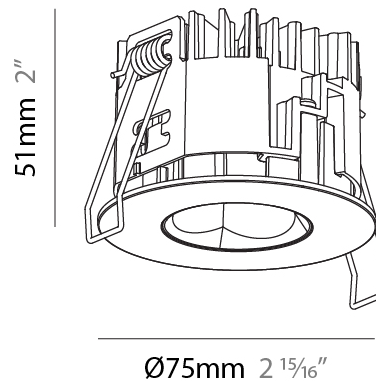

## OIKO PRO ROUND RECESSED

A35872-

PROJECT

TYPE

SPECIFIER

QUANTITY

DATE



A

## OIKO PRO COLOR FINISH CHART

PROJECT \_\_\_\_\_  
 TYPE \_\_\_\_\_  
 SPECIFIER \_\_\_\_\_  
 QUANTITY \_\_\_\_\_  
 DATE \_\_\_\_\_

### Fixture Finish

Sparkling Silver - 01 (SSR)



Black Velvet - 02 (BKV)



Crystal White - 03 (CWI)



Creamy - 04 (CRY)



Hampton Bay - 05 (HAB)



Lagoon - 06 (LAG)



Urban Forest - 07 (UFT)



In the Army - 08 (ITA)



Rusty Angel - 09 (RUA)



Rusty Rush - 10 (RUR)



Milk and Chocolate - 11 (MIC)



Fade to Gray - 12 (FTG)



Mysterious Gray - 13 (MYG)



Twilight - 14 (TWT)



Lost Dream - 15 (LOD)



Purple Sky - 16 (PUS)



Fresh Oh - 17 (FRO)



Funky P. - 18 (FUP)



Kissing Aphrodite - 19 (KIA)



Poseidon's Paradise - 20 (POP)



Blue Sky - 21 (BLS)



Spring Green - 22 (SPG)



Mellow Yellow - 23 (MEY)



Golden Heart - 24 (GOH)



Gun Metal - 25 (GUM)



Champagne Cream - 26 (CHC)



Copper Mine - 27 (COM)



Ancient Bronze - 28 (ABZ)



Jazz Gold - 29 (JAG)



Olive Breeze - 30 (OBR)



Moonlight Silver - 31 (MOS)



Rosewood Red - 32 (ROR)



**Digital:** Not all screens are calibrated the same, and therefore, colors will appear differently between devices.  
**Physical:** When texture is involved, there will be variations in color, character and tone within a product and between product families.







































































**Gun Metal:** No Gun Metal finish is alike. It combines a mixture of transparent and black color particles to ensure a highly individual effect and no luminaire being identical.  
**Champagne Cream, Copper Mine, Ancient Bronze & Jazz Gold:** These finishes have slight fading from specific powder coating production. Each luminaire will slightly vary.

Zaneen Group Inc. • 2245 116th Street, Suite 100 • Burnaby, BC V5A 1R9 • Canada • Tel: 604-291-9319 • www.zaneen.com

Available for International specifications by adding 'INT' at the end of the existing Model #. For assistance on 'custom' specifications, contact zteam@zaneen.com.  
 In a constant effort to supply the best product, we reserve the right to change specifications or materials without notice. The most recent specification sheets are found at zaneen.com

### LEGEND

|  |  |  |
|--|--|--|
|  floor-mounted   |  pivotable  |  special LED (upon request) RGB, RGBW, tunable, gold+, meat+, art+, fashion+                    |
|  wall and ceiling: recessed and surface mounted              |  rotating   |  warm dim / natural dimming LED   |
|  ceiling-mounted and wall-mounted                            |  illuminate tilted  |  rechargeable battery powered   |
|  wall-mounted  |  color of suspension cable                                    |  fixture with natural vivid LED (upon request)  |
|  omni-directional light distribution                         |  length of suspension cable                                   |  color rendering index  |
|  direct light distribution                                   |  reflector degree selection                                   |  color temperature  |
|  direct/indirect light distribution                          |  super spot   |  lumen (luminous flux)  |
|  indirect light distribution                                 |  lens   |  efficacy (lumens per watt)   |
|  asymmetric light distribution                               |  lens pack  |  Unified Glare Rating (UGR) range from 5-40   |
|  aura light distribution                                     |  shine ring   |  marine grade (AISI 316 stainless steel)  |
|  round wall or ceiling cut-out                               |  integrated shine ring with diffuser                          |  walk on  |
|  square wall or ceiling cut-out                              |  free individual colors 01-29                                 |  drive on   |
|  the supplied jig specifies the cutout dimensions            |  individual colors: 00 (free of charge), 01-25 (extra charge) |  Dark Sky Compliance  |
|  minimum distance (meters) lamp - object                     |  luminaire part to be colored (F1)                            |  Americans with Disabilities Act (less than 4" off the wall located between 27"-84" from floor) |
|  recessed depth  |  luminaire part to be colored (F2)                            |  lamp protected against explosion   |
|  ceiling thickness in mm                                    |  luminaire part to be colored (F3)                           |  blown glass using traditional methods by master glass blower                                  |
|  ceiling thickness selection                               |  luminaire part to be colored (F4)                          |  acoustic material  |
|  dimmable DP (phase), DV (0-10V), DD (dali), DS (step-dim) |  luminaire part to be colored (F5)                          |  protection class I, protection insulation  |
|  included or excluded LED driver/transformer/control gear  |  color of 3-circuit adaptor                                 |  protection class II, protection insulation   |
|  separately switchable                                     |  indirect diffuser  |  ETL Certified to UL and CSA Standards  |
|  sensor  |  direct diffuser  |  UL Certified to UL and CSA Standards   |
|  remote control  |  ball-proof (upon request)                                  |  CSA Certified to UL and CSA Standards  |
|  available upon request                                    |  accessory  |  Certified for North American Standards   |

### IP RATING

|  |  |
|--|--|
|  IP20 | protected against ingress of solid bodies greater than 12.5mm (finger)   |
|  IP33 | protected against ingress of solid bodies greater than 2.5mm<br>protected against sprays of water up to 60 degrees from the vertical (rain)      |
|  IP40 | protected against ingress of solid bodies greater than 1mm (wire)<br>no protection against the ingress of moisture                               |
|  IP43 | protected against ingress of solid bodies greater than 1mm (wire)<br>protected against sprays of water up to 60 degrees from the vertical (rain) |
|  IP44 | protected against ingress of solid bodies greater than 1mm (wire)<br>protected against water splashed from all directions                        |
|  IP54 | protected against limited ingress of dust (wet rooms/covered outdoor areas)<br>protected against water splashed from all directions              |
|  IP65 | protected against ingress of dust<br>protected against jets of water   |
|  IP66 | protected against ingress of dust<br>protected against powerful jets of water or heavy seas  |
|  IP67 | protected against ingress of dust<br>protected against immersion of water between 15cm - 1m for 30 minutes                                       |
|  IP68 | protected against ingress of dust<br>protected against immersion of water under pressure for long periods  |

### IK RATING

|  |   |
|--|---|
|  IK01 | protected against 0.14 joules impact (equivalent to 0.25kg mass dropped from 56mm above the surface)  |
|  IK02 | protected against 0.2 joules impact (equivalent to 0.25kg mass dropped from 80mm above the surface)   |
|  IK03 | protected against 0.35 joules impact (equivalent to 0.25kg mass dropped from 140mm above the surface) |
|  IK04 | protected against 0.5 joules impact (equivalent to 0.25kg mass dropped from 200mm above the surface)  |
|  IK05 | protected against 0.7 joules impact (equivalent to 0.25kg mass dropped from 280mm above the surface)  |
|  IK06 | protected against 1 joules impact (equivalent to 0.25kg mass dropped from 400mm above the surface)    |
|  IK07 | protected against 2 joules impact (equivalent to 0.5kg mass dropped from 400mm above the surface)     |
|  IK08 | protected against 5 joules impact (equivalent to 1.7kg mass dropped from 300mm above the surface)     |
|  IK09 | protected against 10 joules impact (equivalent to 5.0kg mass dropped from 200mm above the surface)    |
|  IK10 | protected against 20 joules impact (equivalent to 5.0kg mass dropped from 400mm above the surface)    |